

# Chromosome 1

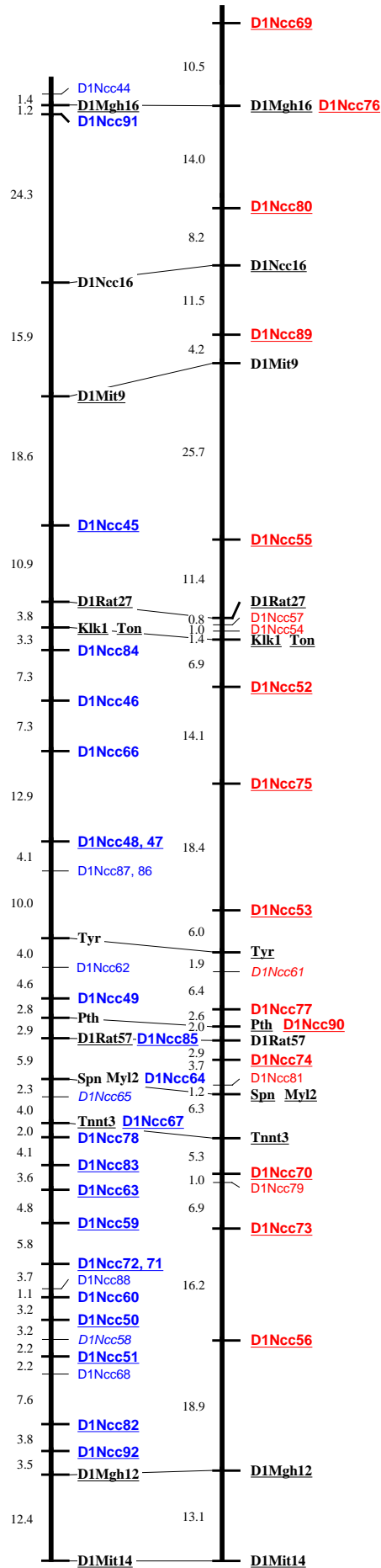

30 AP-RDA markers  
209.2 cM

19 AP-RDA markers  
222.5 cM

# Chromosome 2

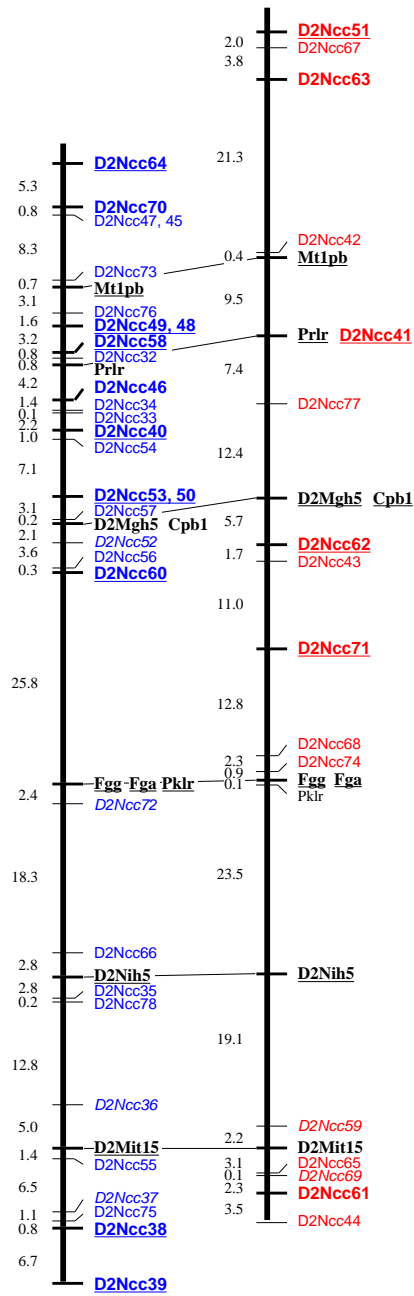

31 AP-RDA markers  
136.4 cM

16 AP-RDA markers  
141.6 cM

## Chromosome 3

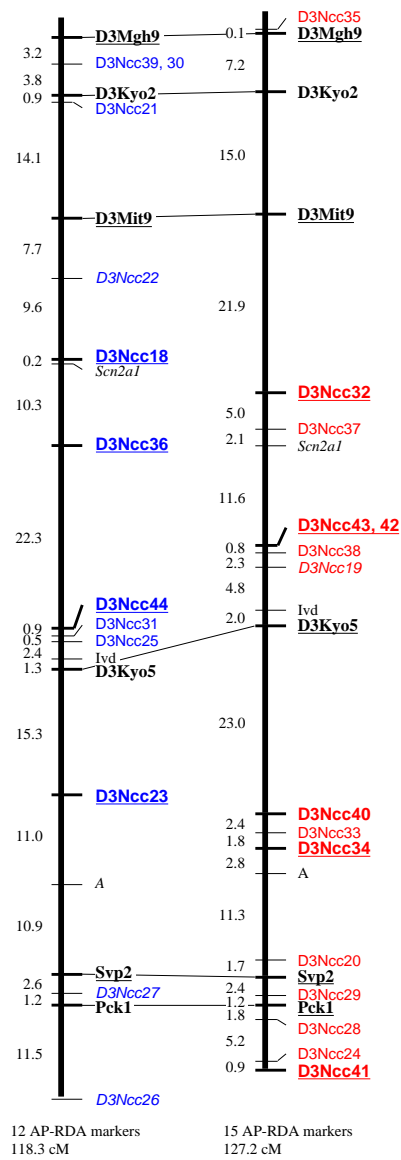

# Chromosome 4

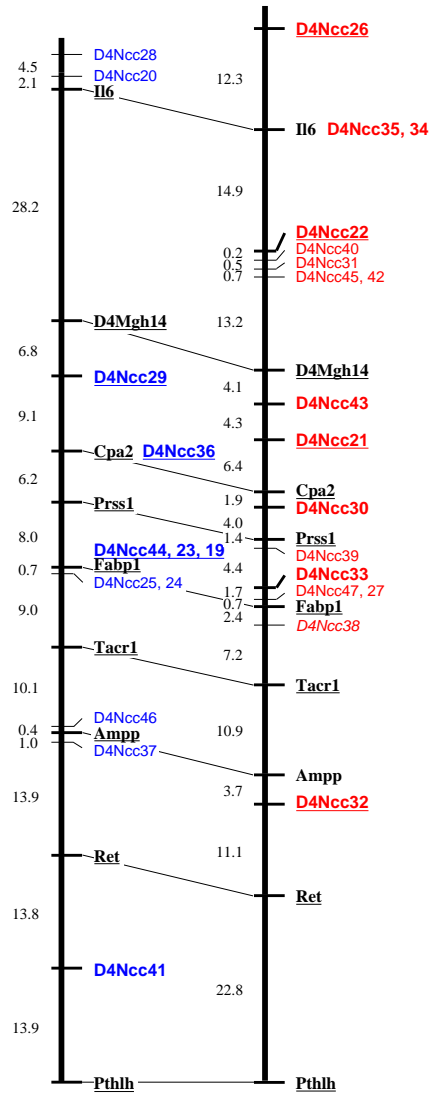

12 AP-RDA markers  
123.3 cM

17 AP-RDA markers  
128.7 cM

# Chromosome 5

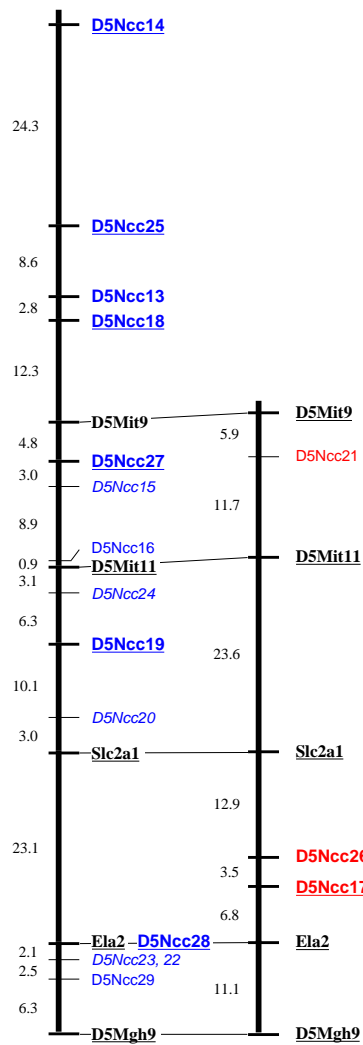

14 AP-RDA markers  
122.0 cM

3 AP-RDA markers  
75.5 cM

## Chromosome 6

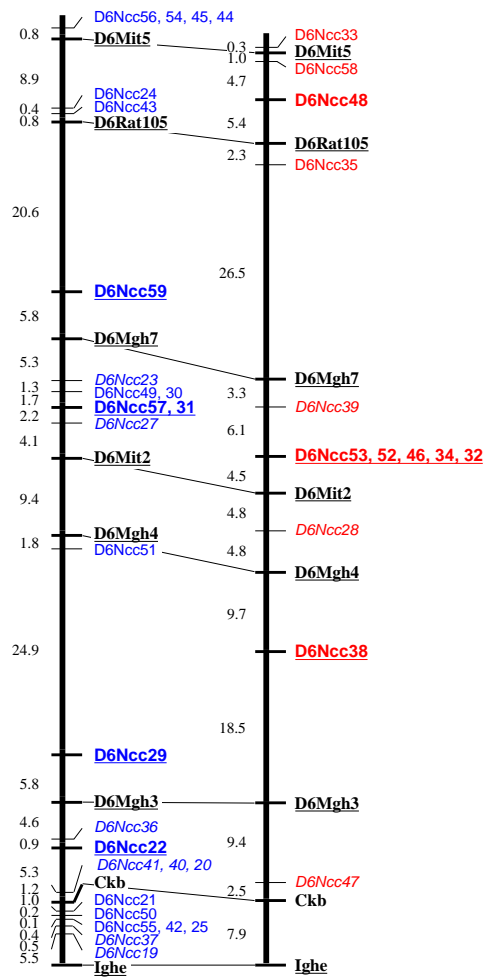

27 AP-RDA markers  
112.6 cM

13 AP-RDA markers  
111.4 cM

## Chromosome 7

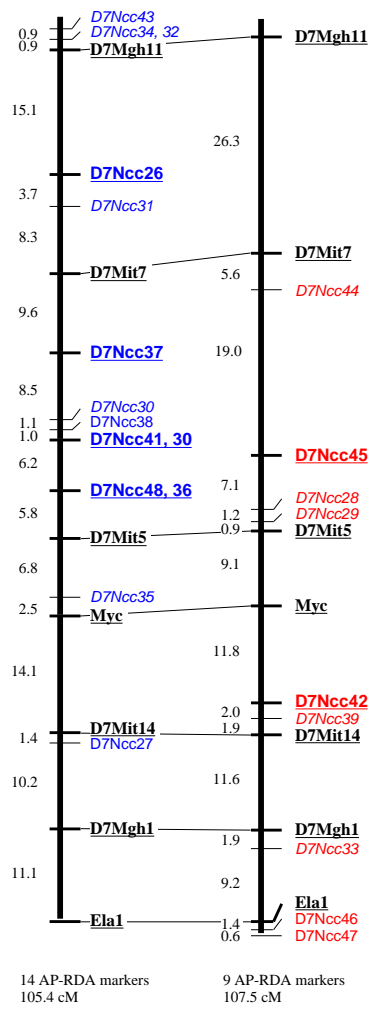

## Chromosome 8

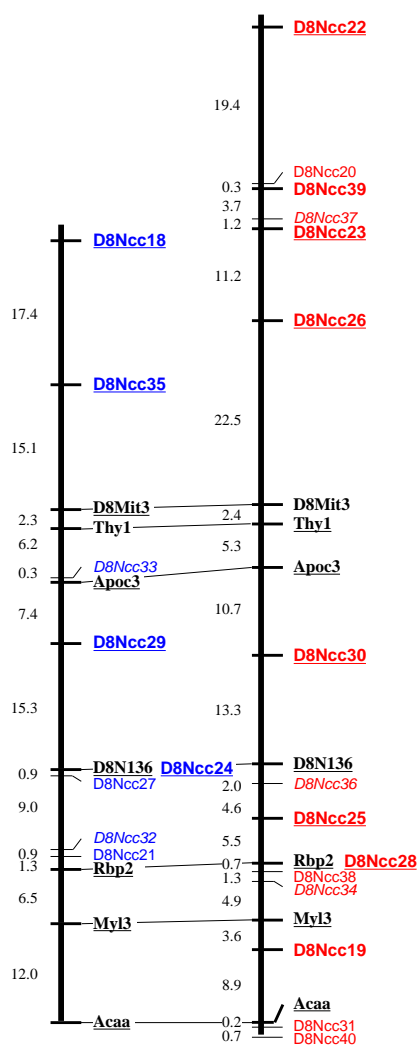

8 AP-RDA markers  
94.6 cM

15 AP-RDA markers  
121.7 cM

## Chromosome 9

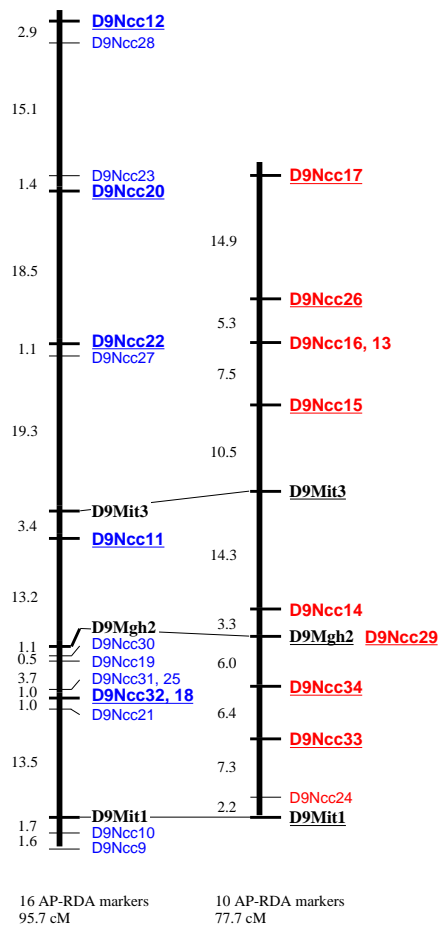

## Chromosome 10

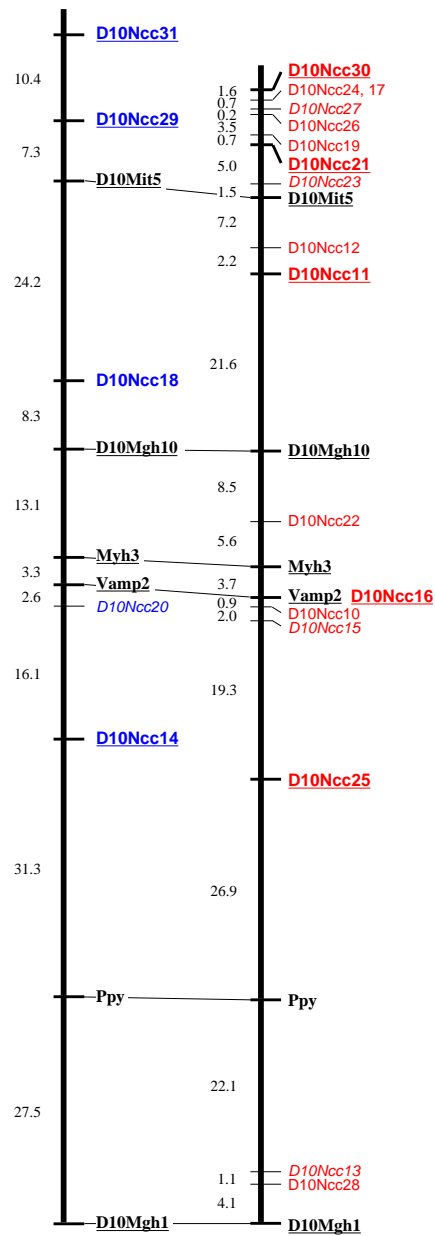

5 AP-RDA markers  
144.2 cM

17 AP-RDA markers  
138.4 cM

## Chromosome 11

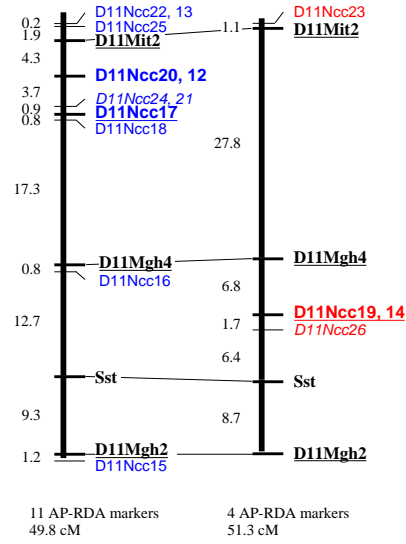

## Chromosome 12

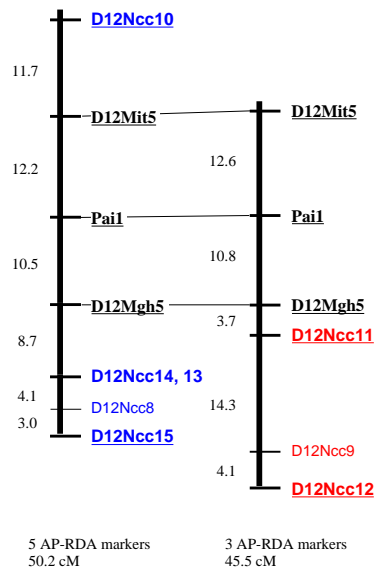

## Chromosome 13

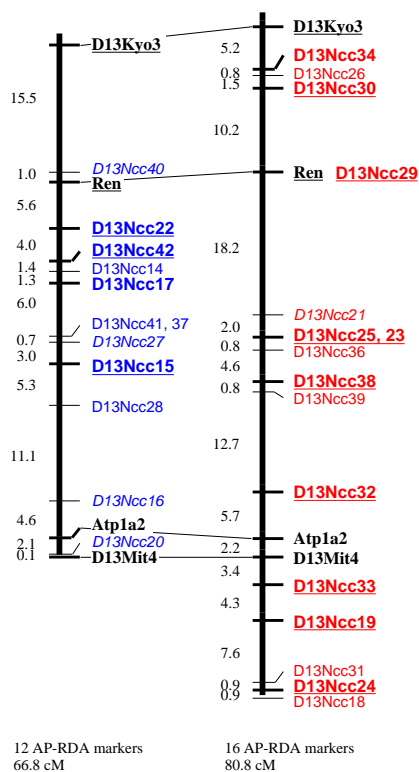

## Chromosome 14

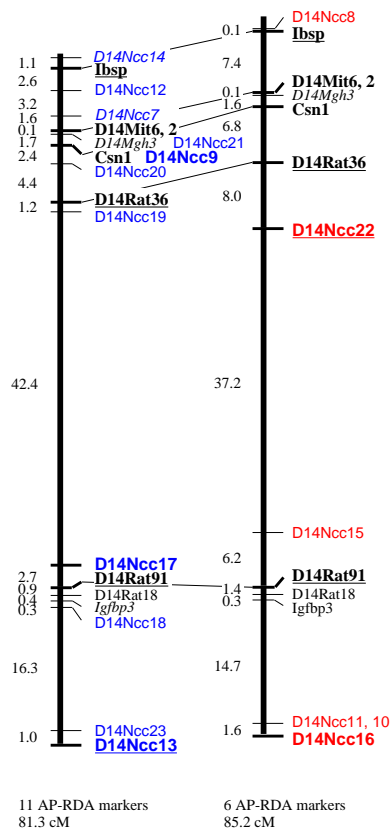

## Chromosome 15

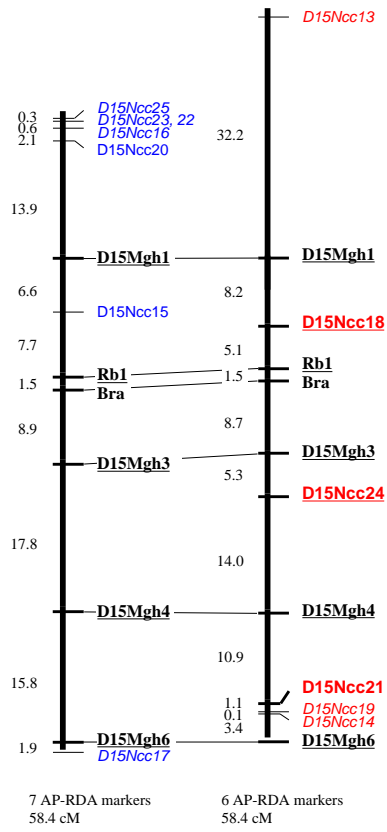

## Chromosome 16

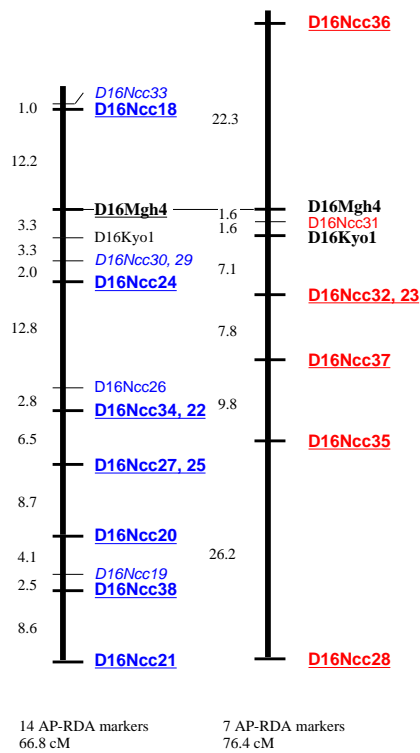

## Chromosome 17

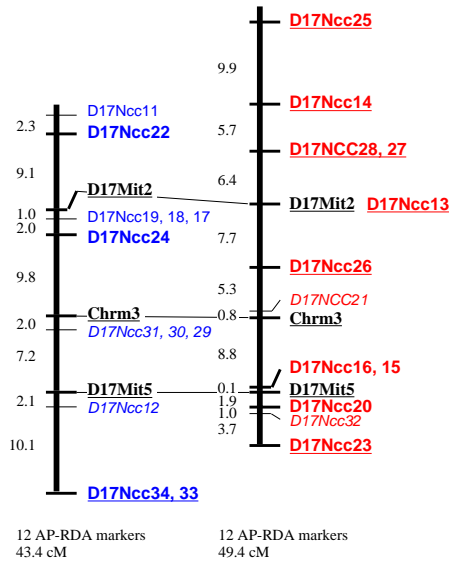

## Chromosome 18

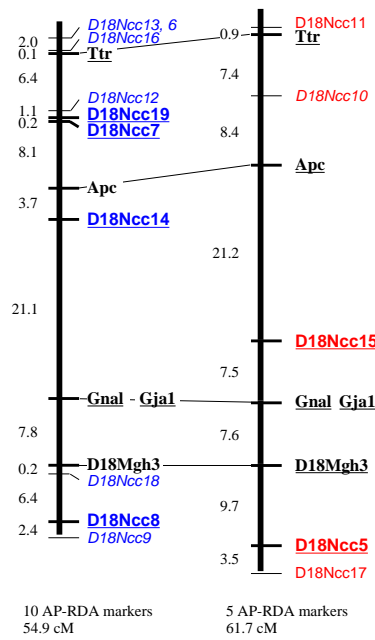

## Chromosome 19

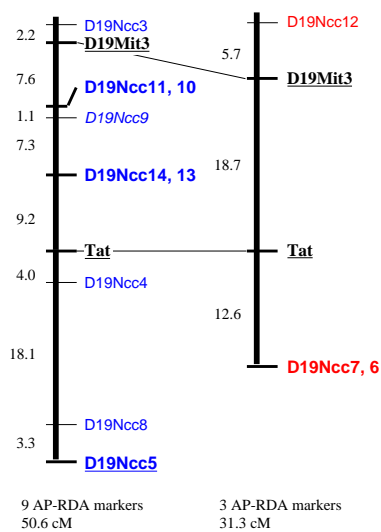

## Chromosome 20

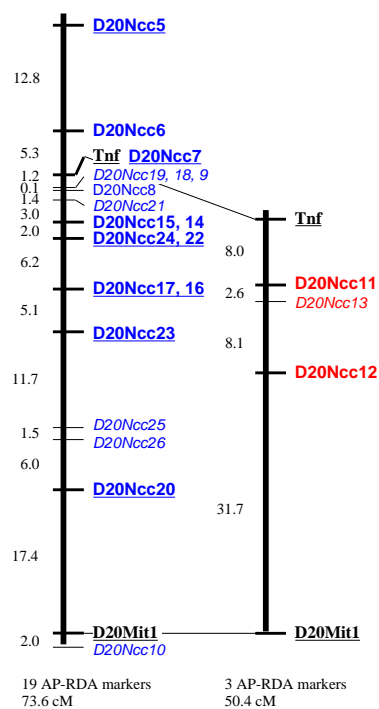

## Chromosome X

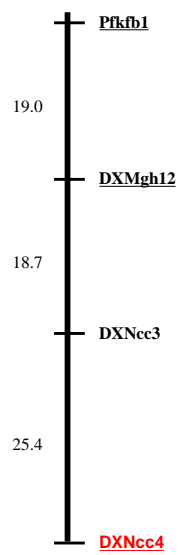

1 AP-RDA marker  
63.1 cM